

# User manual Washer-extractors

WB6-50



**Electrolux**  
PROFESSIONAL



# Contents

---

## Contents

1	. Safety precautions.....	5
1.1	Symbols.....	10
1.2	Personal protection equipment.....	11
1.3	Preliminary instructions.....	11
2	Warranty terms and exclusions.....	13
3	Ergonomics certification.....	14
4	Distributor Letter.....	15
5	Note about the A.C. power.....	16
6	Preparation.....	16
6.1	Loading.....	16
6.2	Detergents.....	18
6.3	Detergent container.....	19
6.4	Maintenance.....	19
6.5	Explanation of accelerometer.....	19
7	Control panel.....	19
8	How to start the machine.....	21
9	Wash programs description.....	22
10	Additional functions.....	25
11	Unloading.....	26
11.1	Unloading side (barrier washer).....	26
11.2	At the end of the day.....	28
12	Daily maintenance.....	28
12.1	General.....	28
12.2	Every day.....	28
12.3	Detergent container.....	28
12.4	Descaling.....	28
12.5	Maintenance to be carried out by qualified service personnel.....	28
13	Error codes.....	29
14	Lubricant table.....	30
15	Explanation of washing symbols.....	31
15.1	Washing.....	31
15.2	Bleaching.....	31
15.3	Drying.....	32
15.4	Ironing.....	32
15.5	Dry or water cleaning.....	32

The manufacturer reserves the right to make changes to design and component specifications.





## 1 . Safety precautions

This machine should be installed in conformance to the health and safety regulations, and only used in a sufficiently aerated area. Check the instructions before installing or using the machine.



### CAUTION



Before any use, to retire all the parts needed to install the machine put in the drum , please follow these actions

1. connect compressed air.
2. Remove the side housing cabinet.
3. Press with a screwdriver on D3B (see picture below).
4. Open the loading door.
5. Open the drum doors , with precautions, maintain the 2 doors.
6. Get the package and instructions.

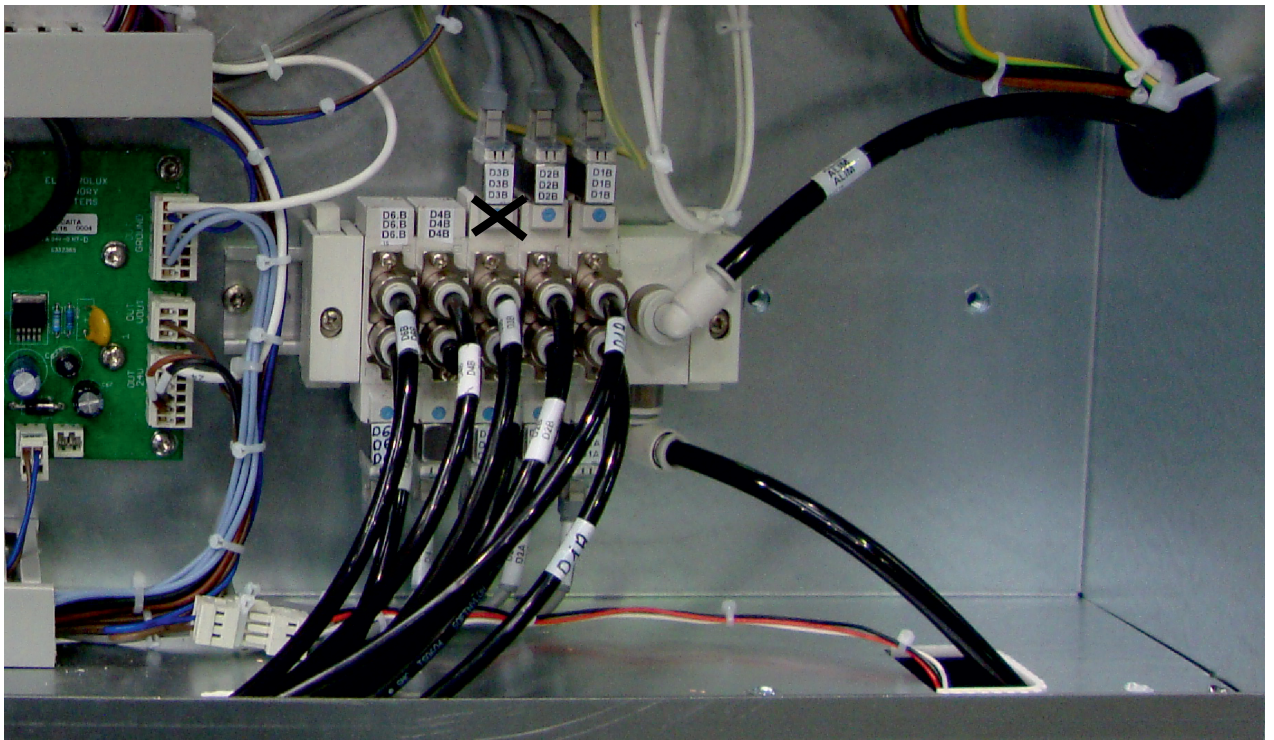

**CAUTION**

Before any use, it is compulsory to read the instruction handbook.

Users must have learnt how the machine operates.

This device must not be installed in places accessible to the public.

The machine is only intended for water-wash use.

Do not allow minors to use the machine.

Do not hose down the machine with water.

Only use detergent intended for water-wash of textiles Never use dry cleaning agents.

It is forbidden to wash textiles soaked with solvents.

The machine's door lock must under no circumstances be bypassed.

If the machine develops a fault, this must be reported to the person in charge as soon as possible. This is important both for your safety and that of others.

**DO NOT MODIFY THIS APPLIANCE.**

Servicing shall be carried out only by authorized personnel.

Only authorized spare parts shall be used.

When performing service or replacing parts, the power must be disconnected.

When the power is disconnected, the operator must see that the machine is disconnected (that the plug is removed and remains removed) from any point to which he has access. If this is not possible, due to the construction or installation of the machine, a disconnection with a locking system in the isolated position shall be provided.

In accordance with the wiring rules : mount a multi-pole switch prior to the machine to facilitate installation and service operations.

In order to prevent damage to the electronics (and other parts) that may occur as the result of condensation, the machine should be placed in room temperature for 24 hours before being used for the first time.

In case of a gas heated machine, do not assemble the machine on premises containing a dry cleaning machines or other similar machines.

Please wash only items offering appropriate distribution inside the drum. Do not wash items such as mattresses or shoes. Call our technical departments before washing nonstandard items. Noncompliance with these instructions may void the manufacturer's guarantee in case of abuse of the washer-extractor.

**CAUTION**

For the following countries : AT, BE, BG, HR, CY, CZ, DK, EE, FI, FR, DE, GR, HU, IS, IE, IT, LV, LT, LU, MT, NL, NO, PL, PO, PT, RO, SK, SI, ES, SE, CH, TR, UK : This appliance shall not be installed where the public has access.

For other countries : This appliance is not intended for use by persons (including children) with reduced physical, sensory or mental capabilities, or lack of experience and knowledge, unless they have been given supervision or instruction concerning use of the appliance by a person responsible for their safety and understand the hazards involved. Children should be supervised to ensure that they do not play with the appliance.

**IMPORTANT**

The identification plate is located on the right side near the main switch.

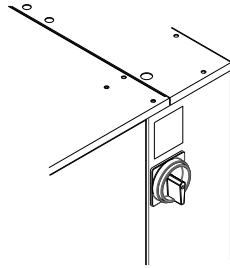

Never use the main switch as an emergency stop. Use it only when the machine does not work in progress. Instead of that, use the emergency stop buttons in both sides of the machine.

**IMPORTANT**

Make sure not to overload the machine. Maximum mass of dry cloth is found in Technical data.  
Sound pressure level is found in Technical data.

**IMPORTANT**

Never try to open the outer drum door before the complete stop of the cage.

**CAUTION**

Disconnect all the sources of energy before any intervention on the machine.



The machines comply with the European Directive EMC (Electromagnetic Compatibility). They have been tested in laboratory and approved as such. It is so prohibited to add wires or nonshielded electric cables in the cabinets, strands or cables' troughs. Considering that the volume of the outer drum is superior to 150 litres, the standard kept for the electric part is the IN 60204.

**CAUTION**

With AIDO(Automatic Inner Door Opening) option, Take care of the disc of the opening system above your head. Risk of cutting with the edge of the disc!!

Take care also of the locking system on your side; risk of cutting with the edge of the plate!!

**CAUTION**

When you put your hands into the drum, take care of the edge of the outer drum doors on yours sides. Risk of cutting with the edge of the metal plate!!

**CAUTION**

The machine can work without the protective casing when the electric supply is not cut off.

Interlock the main isolating switch with a padlock.

Close the steam or gas inlet valves.

**IMPORTANT**

Ensure that the machine is not loaded beyond its nominal capacity (see "Specific load" in the instruction booklet's technical characteristics).

An excessive load has consequences for the lifetime of the machine's organs, as follows:

- Rapid destruction of the suspension elements (springs, shock absorbers);
- Excessive fatigue of motorization elements (engine, belt);
- Rapid reduction of lifetime of drum bearings (rolling bearings);
- Opening and destruction of drum doors and tank doors during oil dehydration.

This is particularly important for your safety and that of others.

The consequence is an immediate cancellation of the warranty.



## THINK OF THE ENVIRONMENT!



The use and handling of chemical products such as detergent, chlorine, acids, descaling agents, etc may create hazards for health and environment ; the following precautions should be taken:

- Do not breathe the dusts or steam;
- Avoid contact with skin or eyes (may cause burns);
- In case of important spillage, wear a protecting mask, gloves, and eye protectors;
- Handle with care;
- Consult the use and first aid advice on the packing;
- Do not dispose pure products in the environment.



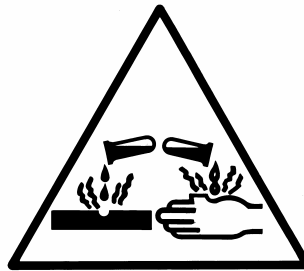

## WARNING



The use and handling of chemical products such as detergent, chlorine, acids, antiliming agents etc... may create hazards for health and environment ; the following precautions should be taken.





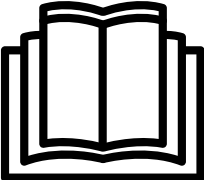

- Do not breathe the dusts or steam.
- Avoid contact with skin or eyes (may cause burns).
- In case of important spillage, wear a protecting mask, gloves, and eye protectors.
- Handle with care.
- Consult the use and first aid advice on the packings.
- Do not dispose pure products in the environment.

**1.1 Symbols**

	Caution.
	Caution, presence of dangerous current.
	Read the instructions before using the machine.

### 1.2 Personal protection equipment

Given below is a summary table of the Personal Protection Equipment (PPE) to be used during the various phases of the machine's service life.

Phase	Protection garments 	Safety footwear 	Gloves 	Glasses 	Ear protectors 	Mask 	Safety helmet 
Transport		X	O				
Handling		X	O				
Unpacking		X	O				
Installation		X	O				
Normal use	X	X	X	X			
Adjustments	O	X					
Routine cleaning	O	X	X	O			
Extraordinary cleaning	O	X	X	O			
Maintenance	O	X	O				
Dismantling	O	X	O				
Scrapping	O	X	O				

**Legend :** X : PPE required ; O : PPE available or to be used if necessary.

**Normal use :** Safety footwear must be defined for a use on a wet floor. And use glasses and gloves to manipulate chemical products.

### 1.3 Preliminary instructions



## WARNING



Risk of jamming when opening the lower door for unloading



## WARNING



Risk of jamming with trolley and lower door when opening (if trolley height = 900mm)

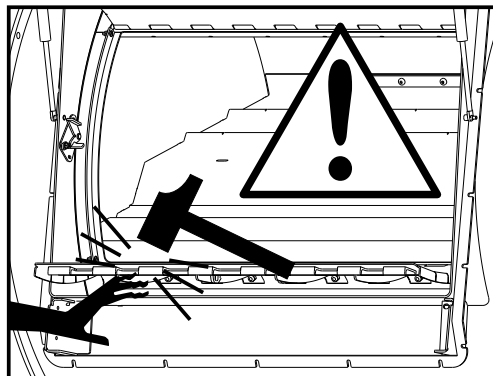

**WARNING**

Risk of the upper door being raised quickly on loading

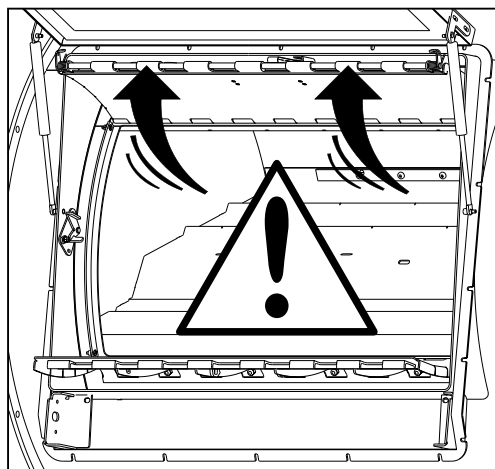
**WARNING**

After the installation, Send back the commissioning form ,signed document, to Electrolux to validate the warranty of the product.



## 2 Warranty terms and exclusions

If the purchase of this product includes warranty coverage, warranty is provided in line with local regulations and subject to the product being installed and used for the purposes as designed, and as described within the appropriate equipment documentation.

Warranty will be applicable where the customer has used only genuine spare parts and has performed maintenance in accordance with Electrolux Professional user and maintenance documentation made available in paper or electronic format.

Electrolux Professional strongly recommends using Electrolux Professional approved cleaning, rinse and descaling agents to obtain optimal results and maintain product efficiency over time.

The Electrolux Professional warranty does not cover:

- service trips cost to deliver and pick up the product;
- installation;
- training on how to use/operate;
- replacement (and/or supply) of wear and tear parts unless resulting from defects in materials or workmanship reported within one (1) week from the failure;
- correction of external wiring;
- correction of unauthorized repairs as well as any damages, failures and inefficiencies caused by and/or resulting from;
  - insufficient and/or abnormal capacity of the electrical systems (current/voltage/frequency, including spikes and/or outages);
  - inadequate or interrupted water supply, steam, air, gas (including impurities and/or other that does not comply with the technical requirements for each appliance);
  - plumbing parts, components or consumable cleaning products that are not approved by the manufacturer;
  - customer's negligence, misuse, abuse and/or non-compliance with the use and care instructions detailed within the appropriate equipment documentation;
  - improper or poor: installation, repair, maintenance (including tampering, modifications and repairs carried out by third parties not authorized third parties) and modification of safety systems;
  - Use of non-original components (e.g.: consumables, wear and tear, or spare parts);
  - environment conditions provoking thermal (e.g. overheating/freezing) or chemical (e.g. corrosion/oxidation) stress;
  - foreign objects placed in- or connected to- the product;
  - accidents or force majeure;
  - transportation and handling, including scratches, dents, chips, and/or other damage to the finish of the product, unless such damage results from defects in materials or workmanship and is reported within one (1) week of delivery unless otherwise agreed;
- product with original serial numbers that have been removed, altered or cannot be readily determined;
- replacement of light bulbs, filters or any consumable parts;
- any accessories and software not approved or specified by Electrolux Professional.

Warranty does not include scheduled maintenance activities (including the parts required for it) or the supply of cleaning agents unless specifically covered within any local agreement, subject to local terms and conditions.

Check on Electrolux Professional website the list of authorized customer care.

### 3 Ergonomics certification

The human body is designed for movement and activity but physical stress injuries as a result of static and repetitive movements or unfavorable working postures may occur.

The ergonomic features of our product, the ones which may influence your physical and cognitive interaction with it, have been assessed and certified.

A product which exhibits ergonomic features, in fact, shall fulfil specific ergonomic requirements, belonging to three different areas: Polytechnic, Biomedical and Psychosocial (usability and satisfaction).

For each of these areas, specific tests with real users have been performed. The product was therefore compliant with the ergonomic acceptability criteria requested by the standards applied.

The product that you use is specifically studied and tested in order to minimise any physical problems associated to the interactions with the product.

The loading and unloading of the linen and the interaction with the product may bring to incongruous postures and to the handling of heavy weights, inherent characteristics of the activity you do we tried to alleviate.

We would like to point out some operating procedures we suggest to adopt:

- Handle the linen in a balanced way, trying not to arch your back during the loading/unloading.
- Take in/out the laundry in small quantities. For example in 20 to 25 times for a WHB5 500, which induces a load of approximately 3 kg with each manipulation.
- In order to avoid the entanglement of laundry including large dishes, add more rotation time in each direction.
- In case of linen entanglement, we advise you to add 30-45s of drain at the end of the program.
- We advise you to use a gripper to catch the laundry at the bottom of the drum. (as picture below)



- If possible, flex your legs and don't bend forward your back during the placement of the linen in the lower box and during the achievement of any lower maintenance actions or items.

- If possible, push the tray cart and pull it in order to reduce the distances.

- Keep the viewing distance in order to understand properly the information displayed in the interface or to view you interest in the drum, reducing as much as possible the time spent with the eyes up (neck extensions).

In case several machines are managed by the same operator the repetitive movements will increase and as a consequence of this the related biomechanical risk will increase exponentially.

Follow the below recommendations to avoid, as much as possible, operators acquiring bodily injury.

- Make sure there are suitable trolleys or baskets for loading, unloading and transportation.
- We advise you to use a mobile bottom trolley with a maximum height of 850mm.
- Organize job rotation in the working place in the case several machines are managed by the same operator.

## 4 Distributor Letter

### Chemical System Responsibility

#### Disclaimer

The following policy should be considered and understood as a warranty/disclaimer to customers operating textile care installations where liquid supply (chemical) systems use or may use peristaltic pumps to inject supplies into equipment.

To Whom it May Concern:

We, the undersigned, accept no responsibility for loss or damage when, during periods of non-use, concentrated chemicals leak, spray or "dribble" onto any part of our machines or their contents.

It is well known that many pumped liquid chemical systems tend to permit concentrated chemicals to dribble out of the injection tubes when the system has not been used for relatively long periods of time – as after working hours and during weekends. This puts highly concentrated corrosive chemicals in direct contact with dry stainless steel surfaces and often directly on any textiles left in the machine. Chemical deterioration (rusting) of the stainless steel and damage to the textiles is the inevitable result.

It is absolutely useless to flush the affected sites after each injection because the ***harmful dribble always occurs later*** – after the machine is no longer in use. One seemingly foolproof solution for "dribbling chemicals" (which we highly recommend but obviously cannot guarantee) is to locate the chemical tanks and pumps well below the injection point on the machine (so the contents of the injection tube(s) cannot siphon into the machine) and to completely purge the just-used chemical injection tube(s), or manifold, with ***fresh water after every injection*** so that only fresh water (which cannot cause a problem) can dribble out. Naturally, this – or any other solution – is the sole responsibility of the pump and/or chemical supplier (not the machine manufacturer).

***Additionally, external chemical leakage is dangerous to personal health and safety***, and will also cause severe damage to machines and/or their surroundings. The installer and/or user of the chemical injection system must make sure there are no external chemical leaks and that excessive pressure can never build up in any chemical delivery tube, ***because excessive pressure can burst the tube, or disconnect it from the machine, and spray dangerous concentrated chemicals about the premises***.

The machinery manufacturer is not, and cannot be, responsible for compliance with the above.

## 5 Note about the A.C. power

According to the EN 60204-1:2018 standard, the machine is provided for A.C. supplies corresponding to the extracted characteristics below :

### 4.3.2 A.C. supplies

#### **Voltage:**

Steady state voltage: from 0.9 to 1.1 of nominal voltage.

#### **Frequency:**

from 0.99 to 1.01 of nominal frequency continuously.

from 0.98 to 1.02 short time.

#### **Harmonics:**

Harmonic distortion not to exceed 10 % of the total r.m.s. voltage between live conductors for the sum of the second through to the fifth harmonic. An additional 2 % of the total r.m.s. voltage between live conductors for the sum of the sixth through to the 30th harmonic is permissible.

#### **Voltage unbalance:**

Neither the voltage of the negative sequence component nor the voltage of the zero sequence component in three-phase supplies shall exceed 2 % of the positive sequence component.

#### **Voltage interruption:**

Supply interrupted or at zero voltage for not more than 3 ms at any random time in the supply cycle. There shall be more than 1 second between successive interruptions.

#### **Voltage dips:**

Voltage dips shall not exceed 20 % of the peak voltage of the supply for more than one cycle. There shall be more than 1 second between successive dips.

## 6 Preparation



### Important



Sort the linen according to the instructions mentioned on the care labels.  
Empty the pockets and clasp the slide fasteners.  
Take care to spread the load of laundry and type of laundry evenly in the two compartments.

### 6.1 Loading

#### Loading side



Press key "Door unblocking".

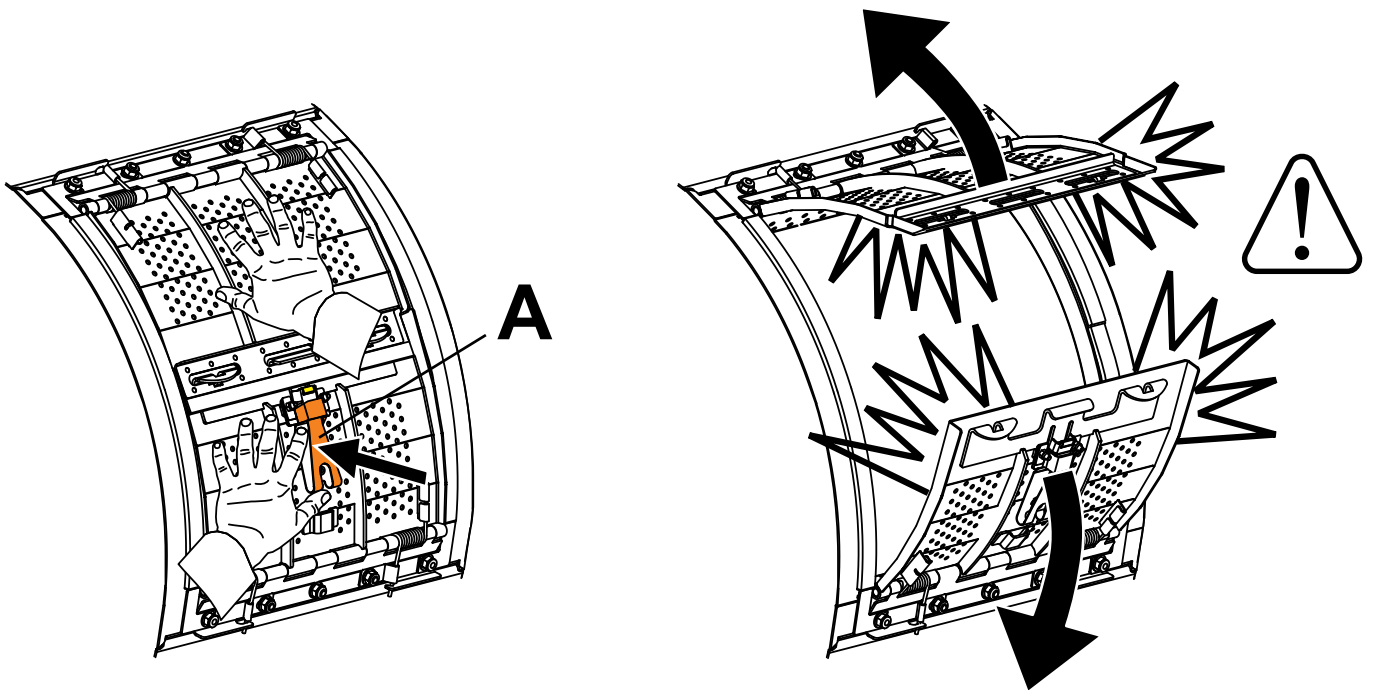

### Open the inner drum doors.

Press the safety latch (A) and at the same time on the upper and lower doors with both hands.

Caution, maintain the doors until they are widely open.

Attention, risk of jamming when opening the doors.

Load the linen in the inner drum. Be careful to distribute it correctly.



### Caution



Make sure not to overload the machine.

#### Maximum load (1/10)

<b>WH5500</b>	50 kg = 2 x 25kg by compartment
---------------	---------------------------------



### Caution



With AIDO(Automatic Inner Door Opening) option, Take care of the disc of the opening system above your head. Risk of cutting with the edge of the disc!!

### Note!

#### Washing in nets

You must note, that it is better to use several nets, three or four in the same compartment rather than one or two. More over, you should finish your load using loose linen if necessary. Divide the number of threads in the two compartments.

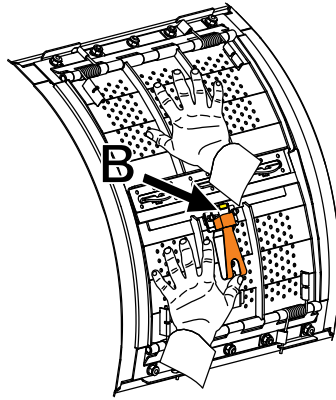

**Close the inner drum doors and press them to check the good working of the mechanical safety device (B).**

If doors are not properly closed, they might open during a washing cycle and strongly damage the machine.

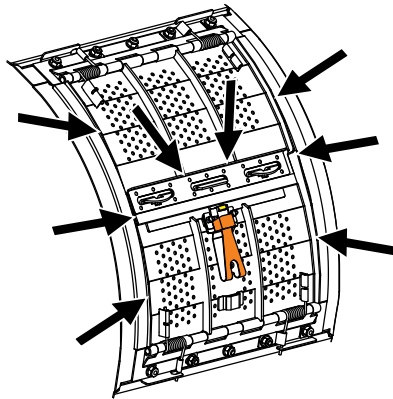

**Check that no piece of linen is wedged between the doors and the inner drum.**

Close the outer drum door and lock it with the handle. The machine is now ready to start the washing cycle.

## 6.2 Detergents

Add the correct amount of detergent and softener according to recommendations.



### Warning



Take care when adding laundry products. Powder or liquids left in the compartments (scoops) may be corrosive.





### Caution



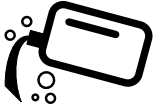

Do not open the cover when the water valves are flushing water through the detergent dispenser. Take care when adding laundry products.

### 6.3 Detergent container

The detergent container has five compartments. Each compartment is connected to a water valve. The water supply to individual compartment is as follows :

	Softener, liquid.
	Main wash for liquid detergent. Alt. for mop machines, liquid mop chemicals in last rinse.
	Pre-wash, powder or liquid detergent, if option "pre-wash" has been selected.
	Main wash for powder detergent.

### 6.4 Maintenance

	<b>Important</b>	
<p>Rinse the inside, every days with water, the detergents container.            Clean the detergent container at regular basis to avoid that it is being clogged by detergent residue.            Clean the detergent container and siphons with hot water and for example a small brush.</p>		

### 6.5 Explanation of accelerometer

The WHB5 appliance has an accelerometer to control the unbalance of the machine during the extraction (spinning) process.

It controls and adjusts speed during spinning process, if the level is not obtain, your linen may be not enough spinned.

In this case, check your loading linen, it must be the same in the two compartments !

And after, select another spinning program.

How does it work?

If the accelerometer detect a problem, then the speed is adjusting and wait several minutes to obtain the right speed.

Then, it can increase the speed to the next level. If not , you never obtain the high speed to obtain a good spinning level.

## 7 Control panel

The control panel is used to choose the wash program with options and to start and stop the machine. The control panel includes a control knob and a display. This control panel also has five preset buttons.

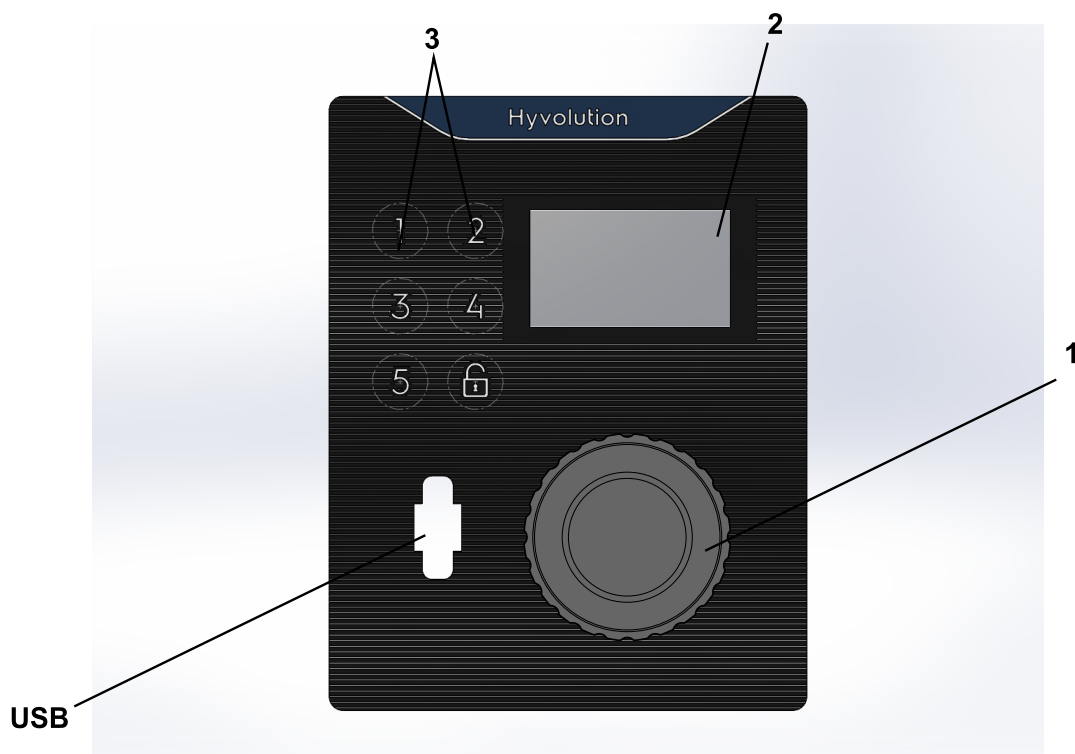

1	Control knob
2	Display
3	Preset buttons

### Control knob

The control knob is used to select wash program, options and any other available functions.

Turn the knob until the required option is shown on the display.

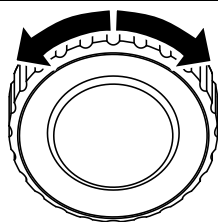

d2120

Confirm your choice by pushing in the knob.

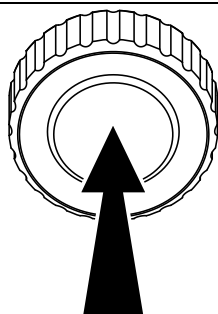

d2121

Repeat this procedure until all the required options have been chosen.



## 8 How to start the machine









Select the desired program by turning the control knob or select program with the quick selection buttons (if some of the buttons are programmed with this function).

It is possible to select options (if some of the buttons are programmed with this function).

### Note!

**Some programs do not allow options.**

Start the machine by pressing the control knob.

Example of programs	Example of options programmed in the buttons	
NORMAL  Different temperatures can be selected. 40°C - 95°C.		PREWASH
MILD  Different temperatures can be selected. 40°C - 60°C.		WASH
HANDWASH 		PRERINSE
		RINSE
		RINSE STOP
		DOOR UNLOCKING

### Buttons

The buttons on the panel can be programmed to be option buttons, quick selection buttons (used to select a program) or both.

At delivery the buttons are programmed to work as options buttons.

The function of the buttons can be changed at any time. Information on how to program the buttons can be found in the Programming and configuration manual and should only be done by a skilled/authorized person.

## 9 Wash programs description

### General

The machine is equipped with a number of programs adapted to the range of use to which the machine is intended. It is recommended to follow the care labelling of the garment as far as possible.



#### Normal 95 — (3H03)

Prewash	No				
Mainwash	8 minutes	85 °C	Hot water	Low level	Signal 2 & 5
Extraction	30 seconds				
Rinse	2 x 2 minutes			High level	
Last rinse	4 minutes			High level	Signal 2
Extraction	7 minutes				



#### Synthetic 40 — (3H03)

Prewash	No				
Mainwash	10 minutes	40 °C	Cold water	Medium level	Signal 2 & 5
Drain	Yes				
Rinse	2 x 2 minutes			High level	
Last rinse	4 minutes			Medium level	Signal 3
Extraction	4 minutes				



#### Heavy soil 95 — (3H03)

Prewash	5 minutes	60 °C	Hot and cold water	Medium level	Signal 1
Mainwash	8 minutes	85 °C	Hot water	Low level	Signal 2 & 5
Extraction	30 seconds				
Rinse	3 x 2 minutes			High level	
Last rinse	3 minutes			High level	Signal 3
Extraction	7 minutes				



#### Heavy soil 60 — (3H03)

Prewash	5 minutes	40 °C	Hot and cold water	Medium level	Signal 1
Mainwash	10 minutes	60 °C	Hot water	Low level	Signal 2 & 5
Extraction	30 seconds				
Rinse	3 x 2 minutes			High level	
Last rinse	3 minutes			High level	Signal 3
Extraction	7 minutes				



#### Normal 70 — (3H03)

Prewash	No				
Mainwash	10 minutes	74 °C	Hot water	Medium level	Signal 2 & 5
Cool down	45 °Cs				
Drain	Yes				
Rinse	2 x 2 minutes			High level	
Last rinse	4 minutes			High level	Signal 3
Extraction	3 minutes				



**Normal 60 — (3H03)**

Prewash	No				
Mainwash	10 minutes	60 °C	Hot water	Low level	Signal 2 & 5
Extraction	30 seconds				
Rinse	2 x 2 minutes			High level	
Last rinse	4 minutes			High level	Signal 3
Extraction	7 minutes				



**Delicate 30 — (3H03)**

Prewash	No				
Mainwash	6 minutes	30 °C	Cold water	High level	Signal 2
Drain	Yes, no rotation				
Rinse	3 minutes			High level	
Last rinse	4 minutes			High level	Signal 3
Extraction	1.5 minutes Low				



**Rinse + Spin — (3H03)**

Prewash	No				
Mainwash	No				
Rinse	No				
Last rinse	4 minutes			High level	Signal 3
Extraction	5 minutes				



**Spin 5 min — (3H03)**

Prewash	No				
Mainwash	No				
Rinse	No				
Last rinse	No				
Extraction	5 minutes				



**Clean door opening — (3H03)**

Prewash	No				
Mainwash	No				
Rinse	No				
Drain	5 seconds				
Last rinse	No				
Extraction	No				

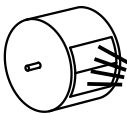

**Descaling — (3H03)**

Prewash	No				
Mainwash	10 minutes	75 °C	Hot water	Low level	Signal 1

Drain	11 secondes				
Rinse	4 minutes			High level	Signal 3
Drain	11 secondes				
Extraction	No				

Library	3H03
Compartment 1	Prewash
Compartments 2 & 4	Mainwash
Compartment 3	Last rinse
Signal 1	Prewash
Signal 2	Mainwash
Signal 3	Softener, last rinse
Signal 5	Bleach, Whitening

## 10 Additional functions

### Note!

Some of the functions may not be available or active on your machine.

### Pause

It is possible to pause an ongoing program.

Press the control knob. A menu will appear on the display. Select **PAUSE** by turning the control knob and press the control knob to activate.

When pressing the control knob again the program will continue.

The door can be opened after a short while if the water level is not too high. Close the door and press the control knob to continue.

### Changing a program after start

It is possible to change a program after start.

Press the control knob. A menu will appear on the display. Select **CHANGE PROGRAM** by turning the control knob and press the control knob to activate.

When pressing the control knob the program menu will be displayed. Select a new program and start by pressing the control knob.

### Rapid advance

If the machine has this function, it is possible to rapid advance an ongoing program.

Press the control knob. A menu will appear on the display. Select **RAPID ADVANCE** by turning the control knob and press the control knob to activate.

When pressing the control knob a list with all program steps will be displayed. Select desired program step from the list by turning the control knob and press the control knob to activate.

### End a program

It is possible to end a program after start.

Press the control knob. A menu will appear on the display. Select **END PROGRAM** by turning the control knob and press the control knob to activate.

When pressing the control knob the program will be ended. When the water is drained the door will be unlocked.

### Delayed start

At the beginning of start program, it is possible to delay the start of the program.

After program selection, press the control knob. A menu will appear on the display. Turn the control knob to activate the function. Set the time for the delayed start with the control knob.

Press the control knob to confirm the settings.

### Status

Press the control knob. A menu will appear on the display. Select **STATUS MENU** by turning the control knob and press the control knob to activate.

The status menu shows the status for water temperature, water level and drum speed for the machine.

### Statistics

Press the control knob. A menu will appear on the display. Select **STATISTICS** by turning the control knob and press the control knob to activate.

The statistics menu shows total run hours and trip run hours for the machine.

### Auto restarts

Press the control knob. A menu will appear on the display. Select **AUTO RESTARTS** by turning the control knob and press the control knob to activate.

Set the number of automatic restarts that the machine will perform of the selected program.

Press the control knob to confirm the settings.

## 11 Unloading

### 11.1 Unloading side (barrier washer)

#### At the end of the wash

When a program has finished, the indicating lamp on the clean side will show when the clean side unloading door can be opened.



#### Caution



With AIDO(Automatic Inner Door Opening) option, Take care of the disc of the opening system above your head. Risk of cutting with the edge of the disc!!

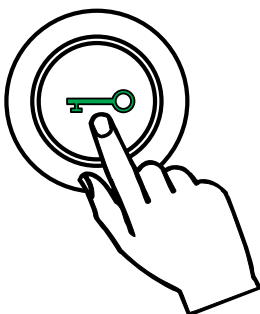

**The green key indicator blinks to indicate you can open the outer door.**

Push on the "Door unblocking key".

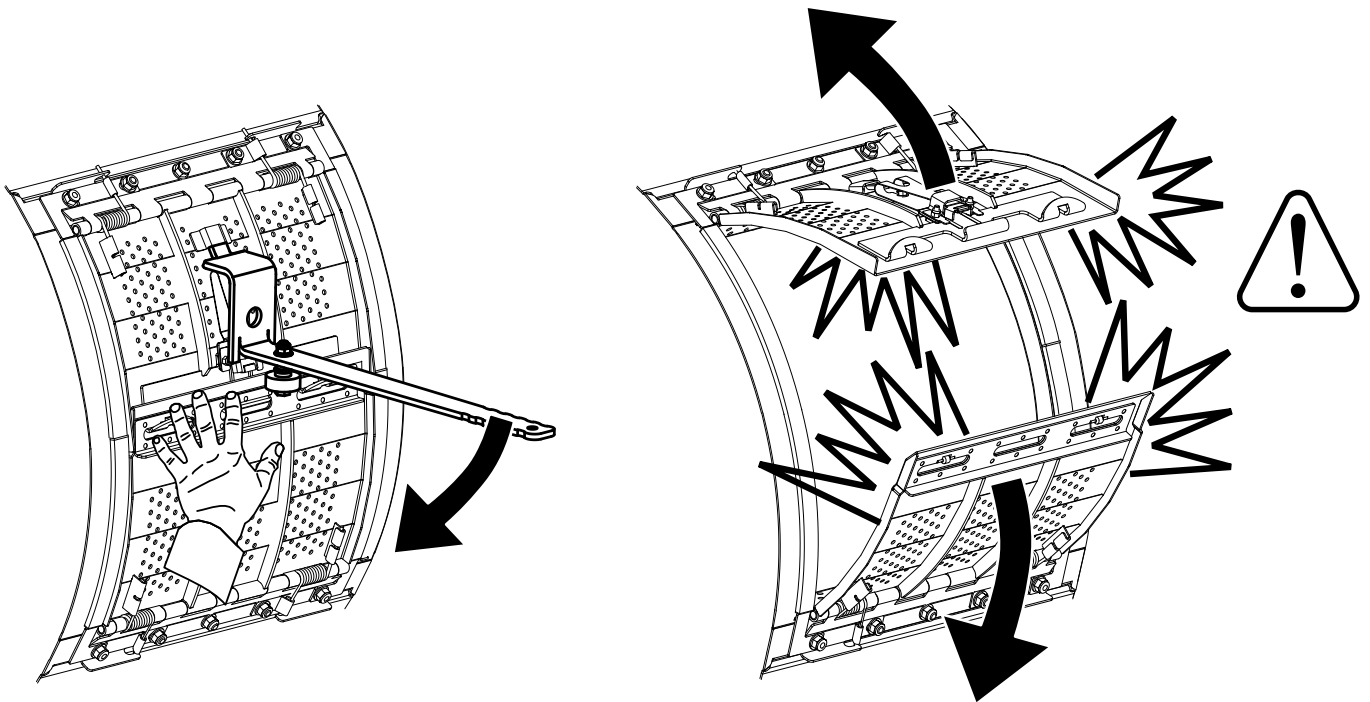

### Open the inner doors using the lever.

Caution, maintain the doors until they are widely open.  
 Attention, risk of jamming when opening the doors.  
 Unload the linen from the inner drum.

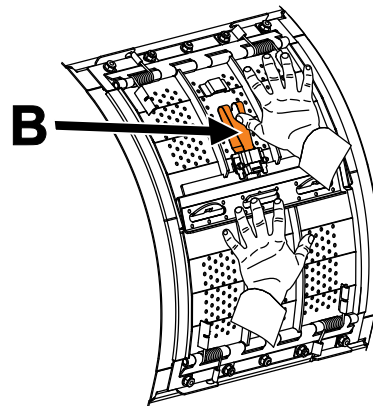

### Close the inner drum doors and press them to check the good working of the mechanical safety device (B).

If doors are not properly closed, they might open during a washing cycle and strongly damage the machine.

Close the outer drum door and lock it with the handle.

The clean side unloading door is now locked and the dirty side loading door can be opened.

The clean side unloading door will only unlock when a program has been successfully completed. If the program has been fast forwarded or an error has occurred (no heating, water missing, other errors, etc.) the machine control system will unlock the dirty side loading door. Then the outer loading door has to be opened and closed again and a program has to be run again in order to secure the wash process\*.

\* This is the case for all programs including sluice programs and rinse + extra programs. Opening the unloading door after a sluice program presents cross contamination issues. The load might not be hygienically clean after only a

sluice program. Therefore it is recommended to add a sluice step to a "normal" program via the option menu when required as opposed to using a sluice program alone.

The machine is now ready for launching a new washing cycle.

## 11.2 At the end of the day

Leave the door open when ready. This is to prevent that moisture stays in the machine and develop bacteria and mould.

## 12 Daily maintenance

### 12.1 General

It is the responsibility of the owner of the machine/the laundry manager to make sure that the following maintenance is performed.

#### Note!

**Lack of maintenance may deteriorate the performance of the machine and may cause damage to components.**

#### Note!

**This is recommended time intervals. Depending on the use of the machine other intervals may be necessary.**

### 12.2 Every day

Check that the "emergency stop button" works properly.

Check that the opening safety devices of the drum doors and of the outer doors are working correctly.

Check that the door is locked during a program. Make sure the door cannot be opened until after the program is complete.

If the door can be opened before program end, the machine must be placed out of order until repairs are made.

Check that the door does not leak.

Clean the door, door glass and door gasket.

Clean the external parts.



### Warning



Do not clean the washer with bleach or oxygenated water to avoid damaging the logos and the control panel of the machine.

We recommend you to use ECOLAB product to clean the washer.

### 12.3 Detergent container



### Important



Rinse the inside, every days with water, the detergents container.

Clean the detergent container at regular basis to avoid that it is being clogged by detergent residue.

Clean the detergent container and siphons with hot water and for example a small brush.

### 12.4 Descaling

When descaling is needed:

Use the special machine cleaning program. If it is not available, contact authorized service personnel to get access to the program.

It is also possible to use a program with high temperature , 95 °C, for descaling. Add a descaling agent, for example citric acid.

### 12.5 Maintenance to be carried out by qualified service personnel

Contact qualified service personnel to perform the following maintenance:

Once a year



- Inspect the interior of the machine during an actual wash cycle to ensure that no leaks are noticed.

### 13 Error codes

In order to limit the risk of failure in the electronic controls of the programming unit of the machine, the machine should be earthed. Should interferences happen, the first thing to be checked is the earthing of the machine.

A fault in the program or in the machine is indicated by an error code on the display.

Some of these error codes can be solved easily without contacting service personnel.

Error code	Text	Cause	Action
10.16	<b>EMERGENCY STOP</b> This error code is displayed if the emergency stop switch has been activated on the machine.	<ul style="list-style-type: none"> <li>• The cause can be inadvertent activation of the emergency stop, defective emergency stop switch, an electrical connection fault, etc.</li> </ul>	<ul style="list-style-type: none"> <li>• Check that emergency stop is not activated. If so, release it.</li> </ul>
11.1	<b>WATER FILL TIME OUT</b> When filling with water, the level specified by the program must be attained within a certain time. This time is normally set to 10 minutes but can vary depending on the type of machine and the software. If the filling time exceeds the maximum allowed filling time, this error code will be displayed.	<ul style="list-style-type: none"> <li>• Electrovalve's filters are blocked.</li> <li>• Long filling times can be caused by a blocked filler valve, defective filler valve, a break in the cable between the filler valve control board, defective valve control board, leaking level system, etc.</li> </ul>	<ul style="list-style-type: none"> <li>• Clean electrovalve's filters.</li> <li>• Check water in main supply.</li> <li>• Open taps.</li> <li>• Check function of drain valve.</li> <li>• Check that level tube is sound and his connection.</li> </ul>
11.2	<b>DOOR OPEN</b> This error code can only arise during an on-going program.	<ul style="list-style-type: none"> <li>• Door unlocked.</li> </ul>	<ul style="list-style-type: none"> <li>• Test whether door really locked.</li> <li>• Switch off power to machine. Wait a minute or so, switch on power supply, open and close door again and try restarting.</li> </ul>
11.3	<b>DOOR LOCK FAIL</b> This error code can arise at program start. If the door lock doesn't lock within a certain time after program start, this error code will be displayed.	<ul style="list-style-type: none"> <li>• Door position acknowledgement not received in time.</li> <li>• This error code will also be displayed if the door switch for locked door signals that the door has been unlocked during an on-going program.</li> </ul>	<ul style="list-style-type: none"> <li>• Open or close the door.</li> </ul>
11.10	<b>DRAIN TIMEOUT</b> This error code is displayed if the water in the drum is not below a pre-determined level when a drain period has been completed in the program.	<ul style="list-style-type: none"> <li>• This error code can be caused by for example a blocked drain, blocked level hose, a water drop in the level hose, defective level control, restricted drain lines to the machine, too many machines emptying simultaneously into drain pipes that are too narrow, etc.</li> </ul>	<ul style="list-style-type: none"> <li>• Check the drain installation and that the waste water can flow freely out from the machine without any restrictions.</li> <li>• Check the drain valve in the machine with regard to dirt.</li> </ul>

For other error codes or repeated error codes, disconnect the power for 30 seconds. If the error code keeps coming back, contact authorized service personnel.

## 14 Lubricant table

MACHINE LUBRICATION								
USES	Rolling bearings Bearings	Rolling bearings Bearings high temperature	Assembly paste (fretting corrosion)	Bare gears Chains shafts Thread Slides	Flange joints Union pipes Steam circuits	Reducers with wheels and screws	Reducers with gears	Circuits and pneumatic devices
TYPES OF LUBRICANTS AND STANDARDIZATION	Lithium soap grease	Lithium soap grease + silicone oil	Lithium soap paste + mineral oil + mineral solid greases	Lithium soap grease with MOS2 additive	Graphite grease mini 60% graphite, special leakproof	Extreme high pressure oil	Extreme high pressure oil	Inhibited oil SAE5
	Grade ISO NLGI2	Grade ISO NLGI3	Grade ISO NLGI1	Grade ISO NLGI2	Grade ISO NLGI2	Grade ISO VG150	Grade ISO VG220	Grade ISO VG22
TEMPERATURE LIMIT RANGE	-20°C + 140°C -4°F + 284°F	-40°C + 200°C -40°F + 392°F	-20°C + 150°C -4°F + 302°F	-20°C + 135°C -4°F + 275°F	-30°C + 700°C -22°F + 1292°F	-0°C + 100°C -32°F + 212°F	-20°C + 120°C -32°F + 248°F	+10°C + 65°C +50°F + 149°F
RECOMMENDED	CELTIA G2	NTN SH44 M	ALTEMP Q NB 50	MI-SETRAL 43N	GRACO AF 309	REDUCTELF SP150	REDUCTELF SP200	LUBRAK ATL SAE 5W
PRODUCT CODE	96 011 011	96 011 019	96 011 014	96 011 000	96 011 004	96 010 001	96 010 004	96 010 030
CORRESPONDENCE								
ANTAR	ROLEXA 2			EPOXA MO2		EPONA Z150	EPONA Z220	MISOLA AH
BP	LS EP2					ENERGOL CRXP150	ENERGOL CRXP220	SHF 22
CASTROL	SPEEROL EP2					ALPHA SP150	ALPHA SP220	
ELF	EP2			STATERMA MO10		REDUCTELF SP150	REDUCTELF SP220	SPINEF 22
ESSO	BEACON EP2			MULTI PURPOSE GREASE MOLY		SPARTAN EP150	SPARTAN EP220	SPINESSO 22
FINA	MARSON EP2					GIRAN SR150	GIRAN SR220	
GBSA					BELLEVILLE N			
GRAFOIL					GRACO AF309			
KLUBER	CENTOPLEX 2	UNISILKON L50Z	ALTEMP Q. NB50	UNIMOLY GL82	WOLFRA-COAT C	LAMORA 150	LAMORA 220	CRUCOLAN 22
MOBIL	MOBILUX					MOBILGEAR 629	MOBILGEAR 630	DTE 24
KERNITE	LUBRA KLC			LUBRA KMP		TOP BLENB ISO 80W90	TOP BLENB ISO 220	LUBRA K ATL SAE5W
SETRAL				MISETRAL 43N				
SHELL	ALVANIA R2			RETINA AM		OMALA 150	OMALA 220	TELLUS 22
TOTAL	MULTISS EP2					CARTER AP150	CARTER EP220	EQUIVIS 22
MOLYKOTE		MOLYKOTE 44	PATE DX					
OPAL	GERVAIR SP			SUPER MOS2		GEAROPAL GM65 ISO 150	GEAROPAL GM75 SO 220	HYDROPAL HO110 HM+ +22
ITECMA	GRL-ULTRA	VULCAIN	SILUB-P	GMO	LHT-C	DURAGEAR BL	DURAGEAR BL	AEROSYN
DOW CORNING		SH 44M						

To lubricate door mechanism of WSB5, use reference 96010068 Loctite LB 8001.















## 15 Explanation of washing symbols

(ISO 3758:2005 standard)

To overcome language barriers, the following are symbols used internationally to give you guidance and recommendations when washing different textiles.



### 15.1 Washing

The tub symbolizes washing.

Symbols	Max. washing temperature in °C	Mechanical action
	95	normal
	95	mild
	70	normal
	60	normal
	60	mild
	50	normal
	50	mild
	40	normal
	40	mild
	40	very mild
	30	normal
	30	mild
	30	very mild
	40	wash by hand
	-	do not wash



### 15.2 Bleaching

The triangle symbolizes bleaching.

Symbols	Explanation
	Bleaching allowed (chlorine or oxygen).
	Bleaching allowed (only oxygen).
	Do not bleach.





### 15.3 Drying

The circle in a square symbolizes tumble drying.

Symbols	Explanation
	Can be put in a tumble dryer. Normal temperature.
	Can be put in a tumble dryer. Lower temperature.
	Do not put in a tumble dryer.



### 15.4 Ironing

The iron symbolizes the domestic ironing and pressing process.





Symbols	Explanation
	Max. temperature 200 °C.
	Max. temperature 150 °C.
	Max. temperature 110 °C. The steam can cause irreversible damages.
	Do not iron.

### 15.5 Dry or water cleaning

The circle symbolizes dry or water cleaning.

Symbols	Explanation
	Normal dry cleaning with perchloroethyl, solvent of hydrocarb.
	Mild dry cleaning with perchloroethyl, solvent of hydrocarb.
	Normal dry cleaning with solvent of hydrocarbon.

---

	Mild dry cleaning with solvent of hydrocarbon.
	Do not dry clean.
	Normal water cleaning.
	Mild water cleaning.
	Very mild water cleaning.







Electrolux Professional AB  
341 80 Ljungby, Sweden  
[www.electroluxprofessional.com](http://www.electroluxprofessional.com)